

# SPECIFICATION SHEET

COLLECTION: BASKETS  
PRODUCT CODE: BAS-2004-C/P



## ACCESSORY TYPE

Baskets

## COLLECTION NAME

Baskets

## FINISH

Chrome

## GUARANTEE

15 Year Guarantee

## MOUNTING

Wall Mounted

tel: 01934 744466  
email: [sales@vado.com](mailto:sales@vado.com)  
[www.vado.com](http://www.vado.com)

WHERE INSPIRATION FLOWS  
TAPS | SHOWERS | ACCESSORIES



# SPECIFICATION SHEET

COLLECTION: BASKETS  
PRODUCT CODE: BAS-2004-C/P

tel: 01934 744466  
email: [sales@vado.com](mailto:sales@vado.com)  
[www.vado.com](http://www.vado.com)

WHERE INSPIRATION FLOWS  
TAPS | SHOWERS | ACCESSORIES



# TECHNICAL DRAWING

COLLECTION: BASKETS  
PRODUCT CODE: BAS-2004-C/P

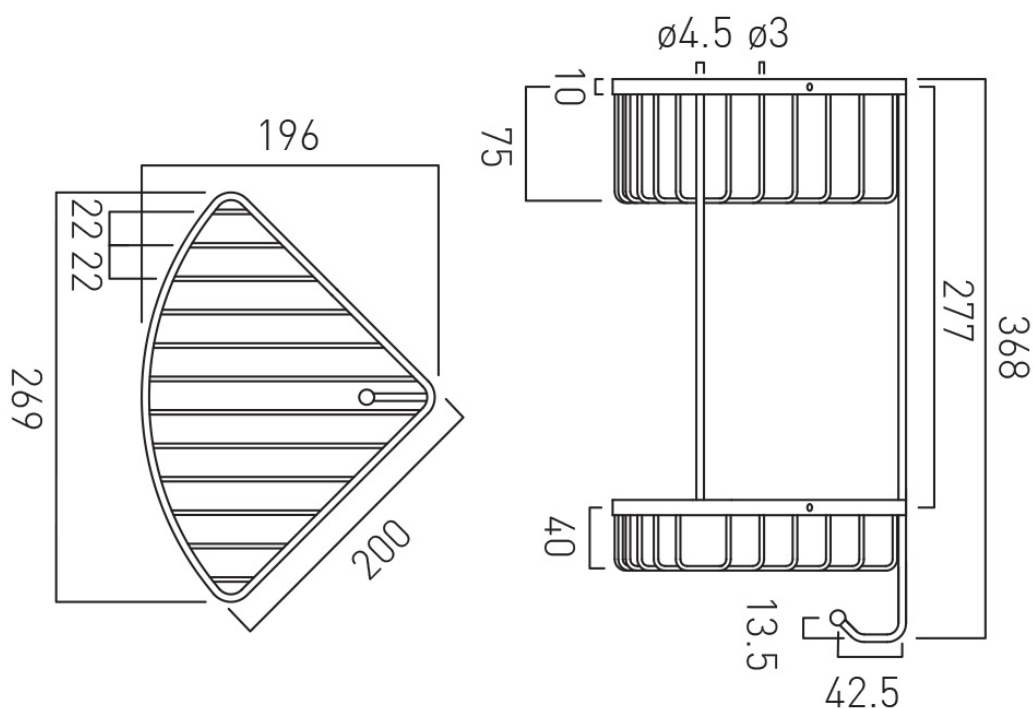

tel: 01934 744466  
email: sales@vado.com  
www.vado.com

WHERE INSPIRATION FLOWS  
TAPS | SHOWERS | ACCESSORIES

