

SPECIFICATION SHEET

COLLECTION: BASKETS
PRODUCT CODE: BAS-2003-C/P



ACCESSORY TYPE

Baskets

COLLECTION NAME

Baskets

FINISH

Chrome

GUARANTEE

15 Year Guarantee

MOUNTING

Wall Mounted

tel: 01934 744466
email: sales@vado.com
www.vado.com

WHERE INSPIRATION FLOWS
TAPS | SHOWERS | ACCESSORIES



SPECIFICATION SHEET

COLLECTION: BASKETS
PRODUCT CODE: BAS-2003-C/P

tel: 01934 744466
email: sales@vado.com
www.vado.com

WHERE INSPIRATION FLOWS
TAPS | SHOWERS | ACCESSORIES



TECHNICAL DRAWING

COLLECTION: BASKETS
PRODUCT CODE: BAS-2003-C/P

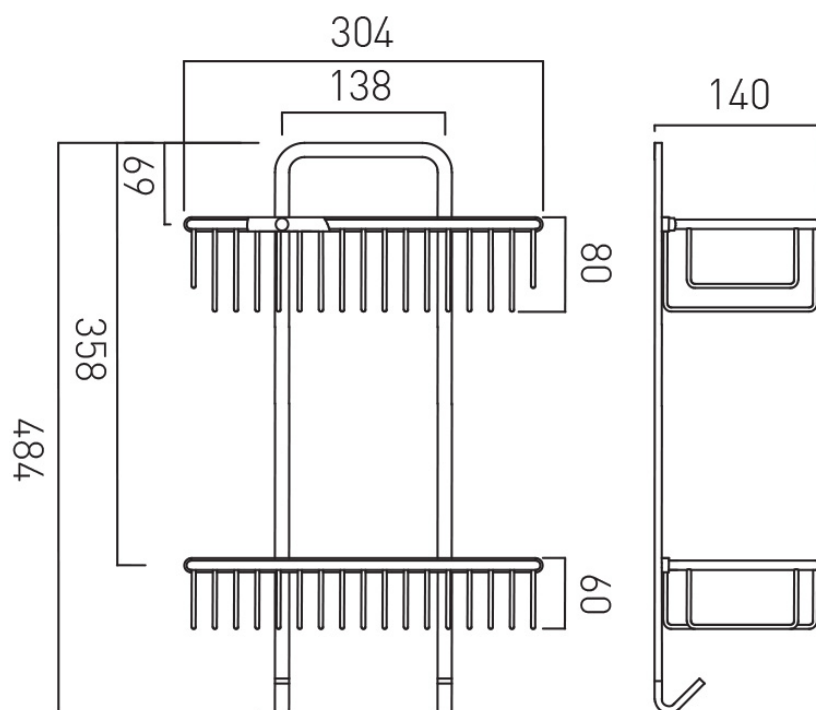

tel: 01934 744466
email: sales@vado.com
www.vado.com

WHERE INSPIRATION FLOWS
TAPS | SHOWERS | ACCESSORIES

